



MAKING MOTORS MAGNIFICENT

VAC TECHNOLOGY AND PROCESS INGENUITY DRIVE SUPERIOR PERFORMANCE

FUTURE- PROOF HIGH PERFORMANCE MOTORS

We live in electrifying times. To reduce our carbon footprint, we (re)turn to electric motors to set an environmentally sustainable future in motion.

VAC excels in providing solutions for next generation electric motors - with permanent magnets, magnetic materials and components made for mission-critical requirements in the field of automotive, aerospace and defense as well as industrial applications.

CREATING COMPETITIVE ADVANTAGES: VAC is the only company with complete control of the process - from raw material melting to complete rotor and stator solutions, from engineering creativity to delicate workmanship, from the customer's idea to its best possible realization. We are your partner for motor development.

VAC IS THE ONLY ONE THAT CAN DO IT ALL!

- ✓ MELTING OF RAW MATERIALS
- ✓ COMPONENTS PROCESSING AND MANUFACTURING
- ✓ PRODUCTION OF RARE-EARTH PERMANENT MAGNETS
- ✓ OPTIMIZING DETAILS ALL ALONG THE PROCESS CHAIN

THE VAC- ADVANTAGE

GETTING ALL THE BEST IN ONE-STOP

When it comes to high performance motors, VAC has the whole package: profound knowledge, a century of experience and groundbreaking technology. From high-end magnetic alloys and permanent magnets to complete rotor and stator assemblies, we develop solutions for the ultimate empowerment of our customers' applications.

DEEP KNOWLEDGE: In 1923, VAC began vacuum melting and tempering alloys, and in 1973, we introduced our rare-earth permanent magnet technology. No other company in the world has this rich combination of knowledge and experience. **The customer's advantage: Best in class alloys and permanent magnet solutions.**

APPLICATION KNOW-HOW: VAC's interdisciplinary team of experts has a deep understanding of the applications we serve, and how our solutions can best optimize customers' applications. **The customer's advantage: Fully optimized solutions.**

MANUFACTURING CAPABILITIES: As a producer of alloys, components and permanent magnets, we have full control over the entire value chain. We maximize the performance of your motor and minimize the losses along the way. **The customer's advantage: Highest level of quality and reliability.**

WHAT MAKES VAC SPECIAL:

- VERTICAL INTEGRATION** → to control every single step along the value chain. **That's our competitive advantage.**
- IN-HOUSE CAPABILITIES** → to be our customers' single point of contact for mission-critical rotor and stator solutions. **That's our unique selling proposition.**
- CLOSED CYCLE** → to reuse 99 % of all production materials to avoid waste of valuable materials. **That's our promise.**
- FULL SERVICE SUPPLY** → to provide the customer with a one-stop-solution for design and development support. **That's our offer.**
- CUSTOMER ORIENTATION** → to provide best-in-class technology to optimize our customers' electric motors. **That's our commitment.**



SOLUTIONS BUILT FOR EXCEPTIONAL MOTOR PERFORMANCE

Game-changing materials and ultra-efficient magnets for high performance stator and rotor assemblies: VAC delivers the mission-critical elements of high performance engines. Whether aerospace, automotive, racing or industrial, VAC's best-in-class solutions make the difference.

PROVIDING THE SOLUTION STACK: The perfect motor depends on the precision and efficiency of every step in the chain. VAC is the ideal partner to manage the whole process and optimize the performance.

COMBINING ALL ADVANTAGES MAKES A PERFECT MATCH: Our portfolio contains all the mission-critical elements you need to develop high performance electric motors. VAC offers a harmonized supply chain, world-class technology and process capability from a single source.

30 % HIGHER TORQUE

By using VACODUR® materials and VACODYM® magnet assemblies the torque of a motor can be increased significantly compared to standard technology.

POWERFUL MAGNETS

VACODYM magnets have a 10 times higher energy density than common ferrite magnets and provide the motor with a significantly higher torque.

MINIMAL HEAT GENERATION

In electric motors eddy currents generate heat. With our segmented magnets and proprietary alloy technologies we significantly reduce the generation of these eddy currents.

ADVANCED MAGNETIC MATERIALS

CoFe magnetic materials from VACOFLEX® and VACODUR offer high saturation and yield superior performance parameters for electric motors and generators.

VACSTACK® TECHNOLOGY

Best-in-class cobalt-iron laminations with a strip thickness down to 50 µm and a filling factor of >96 %.

LIGHT-WEIGHT MOTORS

Optimized materials and manufacturing precision enable smaller motors with high power densities more than 10 kW/kg.

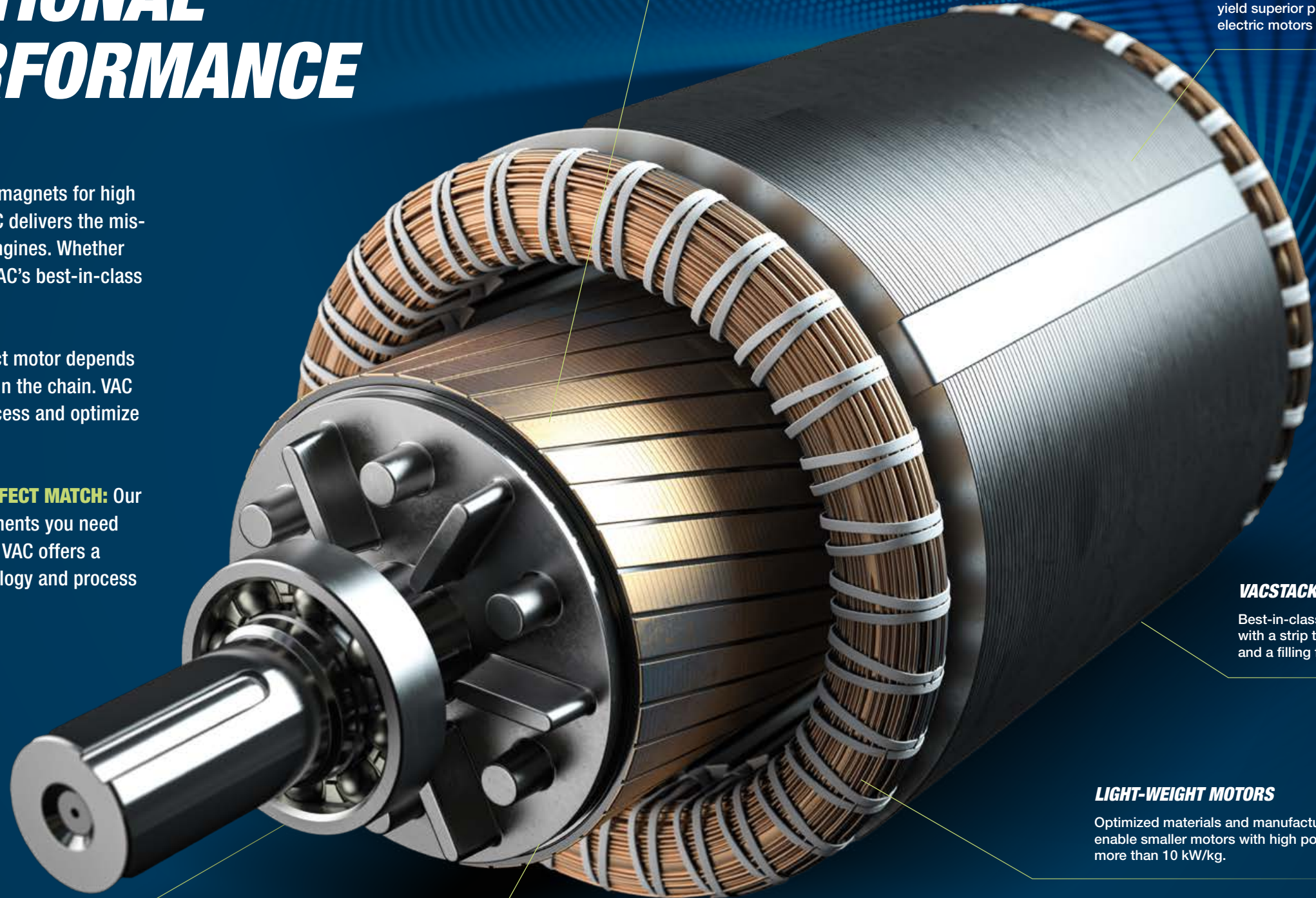

FOR MOTORS FROM
WATT TO MEGAWATT

COMPLETE IN-HOUSE CAPABILITY:

COMPONENTS FOR ELECTRIC MOTORS AND GENERATORS

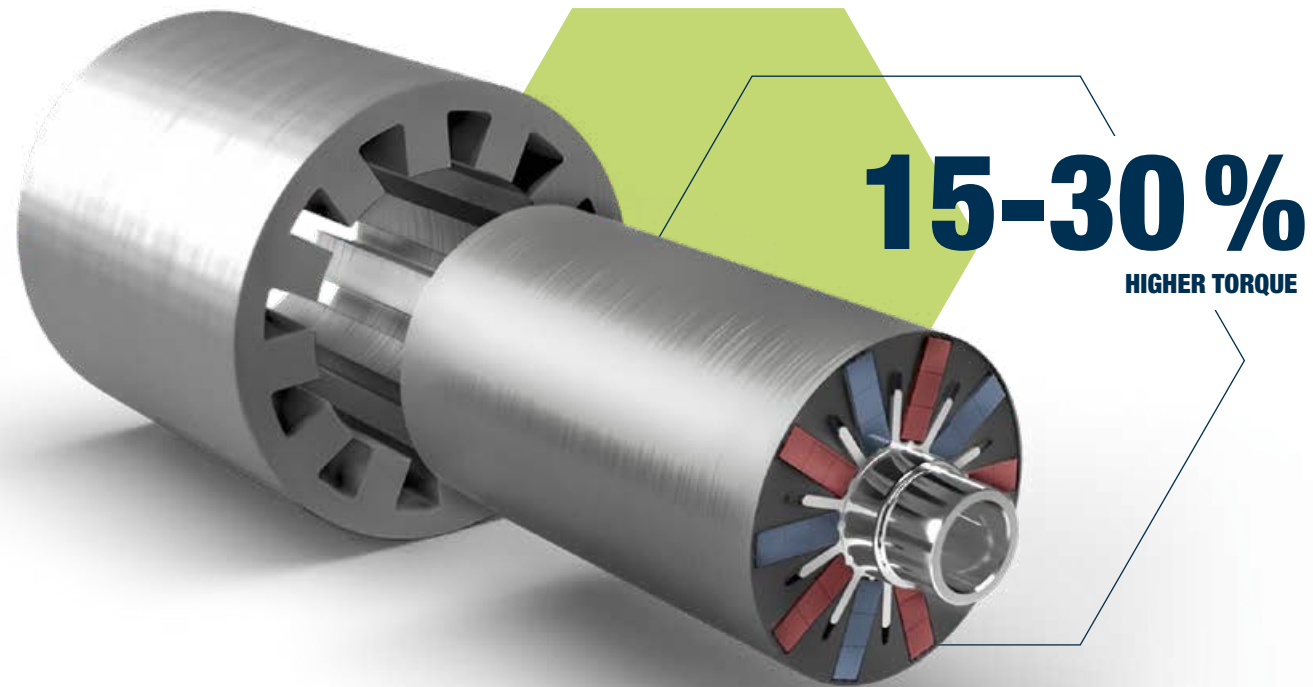

MATERIALS

TWO STAGES OF PERFECTION: VACODUR 49 AND VACOFLEX X1

FOR HIGH PERFORMANCE AND MAXIMUM PERFORMANCE DEMANDS: VAC CoFe alloys meet the requirements of the market. For their respective applications, each of them bring the same property: optimum performance capability.

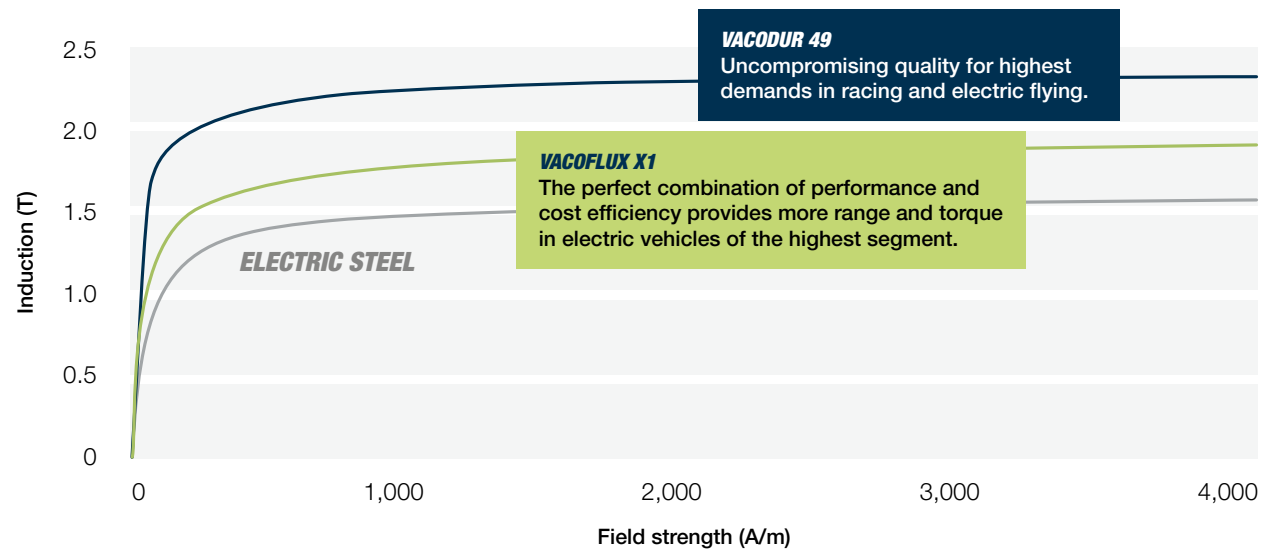

COMPONENTS

FROM MATERIAL TO FINISHES PRODUCT - ALL FROM A SINGLE SOURCE

AS A FULL-RANGE SUPPLIER of magnetic solutions, VAC combines material knowledge with manufacturing expertise. Our vertical integration enables precise harmonization of every individual step of the process. The advantages are obvious: Since VAC controls every step from material production and manufacturing of parts to the assembly of complete components such as rotors or stators, individual customer requirements are taken into account in every step of the process.

OUR CUSTOMERS' ADVANTAGE: Customers enjoy a comprehensive network of support from material science through process, to final stator and rotor assembly. A customer tailored focus to maximize performance, reduce cost and scrap, in a holistic supplier-partner relationship.

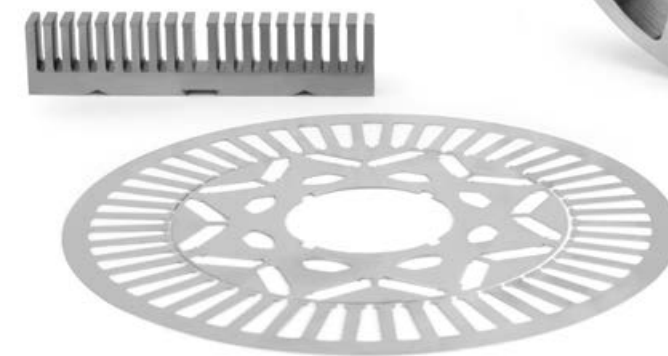
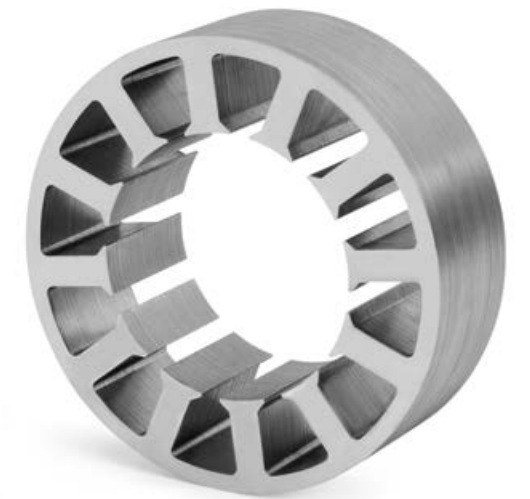

PERMANENT MAGNETS

HIGHER PERFORMANCE AT LOWER TEMPERATURES

PERMANENT MAGNETS ARE THE MUSCLES of a powerful electric motor. The magnet systems must work perfectly together with rotor and stator so that the motor can achieve maximum performance. VAC segmented permanent magnets significantly reduce eddy currents, which reduces heat and improves the overall motor performance.



APPLICATIONS

LOWER WEIGHT, HIGHER EFFICIENCY: POWER-DENSITY AT ITS BEST

Rotors and Stators made of special cobalt-iron alloys and permanent magnets from VAC are now as well established in the world of motor sports as the steering wheel. Beyond the track, VAC is breaking records and driving performance in many applications such as electric vehicles, aerospace, defense, and industry 4.0.

WHEN TOP PERFORMANCE IS REQUIRED IN THE TIGHTEST OF SPACES, VAC MAKES ROOM FOR THE RIGHT SOLUTIONS.

LONGER RANGE

Combination of NdFeB permanent magnets, and lightweight power dense cobalt-iron stators increase range and battery life.

LESS WEIGHT

Kilowatt-to-kilogram optimization is the future of e-flight. Power dense alloys and rare-earth permanent magnets are mission-critical.

HIGHER SPEED

VACSTACK technology is a game changer optimizing speed and performance.



AUTOMOTIVE

WHEN FAST AND FURIOUS IS NOT ENOUGH:

**WORLD CLASS PERFORMANCE
ON RACE TRACKS AND ON THE ROAD**

FORMULA 1
VAC solutions for ERS systems provide the critical extra power boost.

FORMULA E
VAC solutions drive the all-electric Formula series.

**WHERE VAC
IS IN THE
STARTING GRID:**



FORMULA STUDENT ELECTRIC
From 0 to 60 mph in 1.461 sec.: VAC components achieve world records.

PARIS DAKAR
With electric power through the desert: VAC components make it possible.

SPORTS CARS & HYPERCARS
VAC brings top performance from racing to the road.

WORLD ENDURANCE CHAMPIONSHIP
VAC components let hybrid prototypes master the "Green Hell" of the Nürburgring and the Circuit de la Sarthe.



VAC is the leading manufacturer of electric motor components used in the most reputable racing series of the world. From legendary tracks like the "Green Hell" or the Circuit de la Sarthe to the tracks of Formula 1 and Formula E, and the off-road trails between Paris and Dakar. VAC products elevate the level of competition in motorsports.

INTERPLAY OF COMPETENCIES: For years, racing engineers have relied on cobalt-iron alloys and high performance magnets from VAC for electric motors. The alloys with their distinctive properties are created in an in-house developed melting process. The ultra-thin CoFe sheets are layered on top of each other using VACSTACK technology and are processed into rotor and stator systems using the company's own permanent magnets. With a sheet thickness as low as 50 µm and segmented magnets, harmful

eddy currents are reduced to a minimum and the engine gains significant power and agility. Today it is impossible to imagine Formula 1 without these high performance components as part of the Energy Recovery System (ERS). Formula E relies on the advantages of the stacked cobalt-iron laminations, and rare earth permanent magnets in their electric motors. Our solutions also withstand the rugged environment of 24-hour endurance races delivering performance in extreme conditions.

MORE POWER FOR E-MOBILITY: The migration to electric or hybrid vehicles is creating a growing need for highly efficient and powerful electric motors not only in professional racing but also in the premium sports car sector. Conventional electric steel is no longer sufficient in many cases. VAC offers two solutions here.

VACODUR 49 is the race-proven top alloy. With an induction of up to 2.3 Tesla, even a motor the size of a conventional beverage can achieves an output of around 50 hp.

VACOFLUX X1 combines performance with economy: A torque increase of a solid 15 % in comparison to conventional electric steel is matched by a 50 % cost saving compared to VACODUR 49.

**UNBEATABLE ADVANTAGES
OF VAC TECHNOLOGY:**

- LESS WEIGHT
- SMALLER SIZE
- HIGHEST POWER DENSITY
- BEST IN CLASS SATURATION
- LONGER RANGE

VAC alloys can significantly improve the range or reduce the battery size in on-road vehicles by providing lightest weight power dense solutions. Whether you are looking for greater range or high-speed performance, VAC is the partner of choice.

AEROSPACE & E-FLIGHT

AN UPLIFT FOR ELECTRIC POWER UNITS:

ENABLING FUTURE OF FLIGHT

Whether it be high performance drones, E-VTOLs, hybrid-electric, or fully electric propulsion, the future of flying depends on “kilowatt-to-kilogram”. VAC is the only company in the world that can produce from raw materials to finished stators and complete rotor assemblies with rare earth permanent magnets. Our ability to drive out weight and increase power density from the material level through final solution ensures a best in class solution.

WHY ELECTRIC AND HYBRID-ELECTRIC FLIGHT IS IMPORTANT

ENVIRONMENT: Global aviation accounts for roughly 1 billion tons of CO₂ per year, which is more than the emissions of most countries.

COSTS: According to the International Air Transport Association (IATA), the annual cost of aviation fuel worldwide is estimated to be 200 billion USD. This represents approximately one quarter of all total airline operating expenses.

A CONNECTED WORLD: Prior to COVID-19, 4.3 billion passenger trips were recorded annually. This volume of travel is unsustainable without severe economic and environmental impacts.

THE SKY IS NO LIMIT: WHY VAC PRODUCTS ARE PERFECTLY SUITABLE FOR AVIATION

- **REDUCED WEIGHT** (up to one-third) extends range and battery life
- **HIGHEST EFFICIENCY** due to lowest losses and minimal heat generation
- **CONTROL** of the production chain guarantees benchmark-setting quality
- **CERTIFIED** according to EN 9100

WHY PROCESS OPTIMIZATION MATTERS

Specialty alloy stators and rare-earth permanent magnet rotors are critical elements of high performance, light weight, efficient electric motors. VAC is the only company in the industry that has the ability to provide both and that manufactures from raw materials to final stator pack and rotor assembly.

HOW CAN THIS IMPROVE YOUR MOTOR?

TIGHT TOLERANCES: By processing both critical elements in one house VAC controls the tolerance stack-up during each phase of production. This will give you the possibility to work with smallest tolerances in your motor design.

LIGHT-WEIGHT: By providing both, rare-earth permanent magnets and stator technology, VAC can optimize power density while reducing weight to give your motor maximum efficiency.

ZERO SCRAP: As VAC manufactures from raw materials to final product, we can recycle up to 100 % of the scrap material to save valuable resources to reduce costs.

COSTS: With VAC, you work with a single supplier who is able to control the whole critical rotor and stator portion of the motor development process. Without VAC this process could require as many as five independent suppliers, which adds cost, complexity, and introduces failure-modes to the overall process.

HIGH PERFORMANCE DRONES



E-VTOLS / AIR TAXIS



ELECTRIC & HYBRID AIRCRAFTS

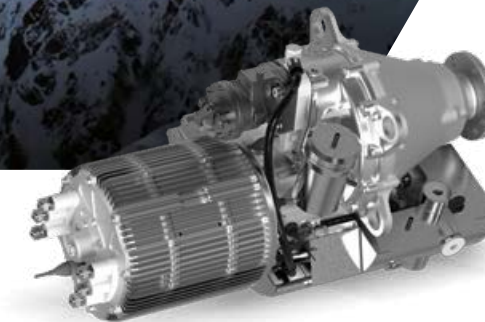

THIS IS HOW WE SHAPE THE FUTURE:

VAC is actively participating in multiple global development projects to further enhance the power density, reduce weight, improve efficiency, and performance of electric motors. Our technology makes a difference!

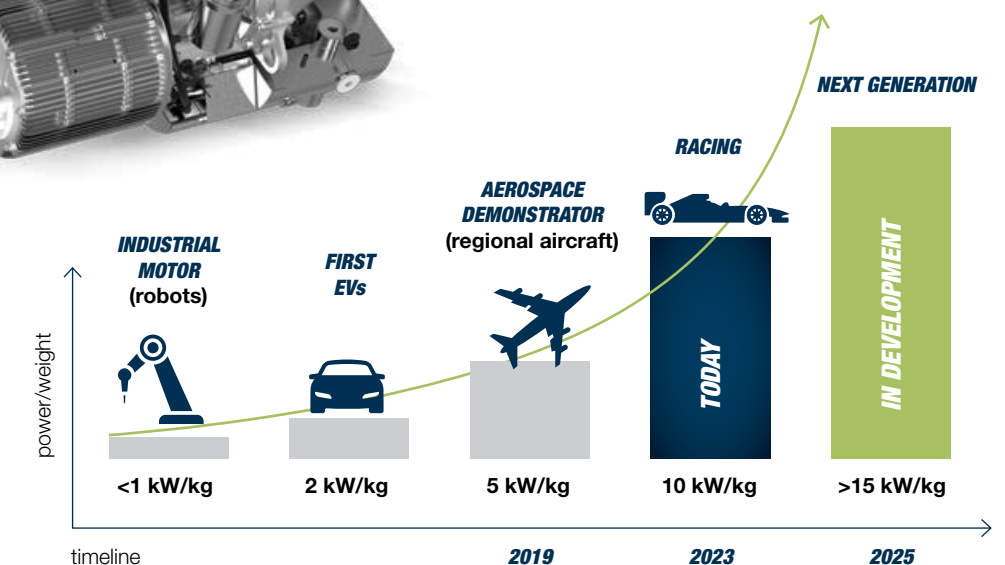

INDUSTRIAL APPLICATIONS

FUTURE-PROOF TECHNOLOGY:

SOLUTIONS MAKING ADVANCED AUTOMATION WORK

In more and more areas, electric motors are replacing classic hydraulic motors. They require less maintenance and reduce potential contamination in industrial process.

LIGHT WEIGHT SMALL MOTORS made from VAC alloys and rare-earth permanent magnets deliver significantly higher power density in smaller packages. Enabling advancements in robotics, exoskeletons and process automation.

E-MOTORS USING VAC TECHNOLOGY provide high efficiency and performance. VAC cobalt-iron alloys enhance the power density up to 30 %, while leveraging extremely thin laminations to reduce eddy currents and improve motor efficiency. Additionally, VAC's rare-earth permanent magnets with near-net-shape technology offers tighter tolerances, and lowest losses to further improve the overall motor performance.

WHERE VAC SOLUTIONS CAN MAKE A DIFFERENCE:

- ROBOTICS
- EXOSKELETONS
- PROCESS AUTOMATION
- INDUSTRY 4.0



EXOSKELETONS

CHIP PRODUCTION &
TOOLING MACHINES



INDUSTRIAL ROBOTS

VACUUMSCHMELZE GMBH & CO. KG

Grüner Weg 37
D 63450 Hanau / Germany

Phone: +49 6181 38 0
Mail: info@vacuumschmelze.com

VAC MAGNETICS LLC

2935 Dolphin Drive
Suite 103
Elizabethtown, KY 42701

Phone: +1 270 769 1333
Mail: info-usa@vacmagnetics.com

VACUUMSCHMELZE CHINA MAGNETICS

Shanghai Sales Office
Room 06, 19F
Zhongrong Hengrui International Plaza
620 Zhangyang Road, Pudong District
Shanghai, PRC 200122

Phone: +86 21 58 31 98 37
Mail: vac_china@vacuumschmelze.com



WWW.VACUUMSCHMELZE.COM

Components for Electric Motors
Published by VACUUMSCHMELZE GmbH & Co. KG, Hanau
© VACUUMSCHMELZE GmbH & Co. KG. All rights reserved.

® is a Registered Trademark of VACUUMSCHMELZE GmbH & Co. KG